

Blueberry Bunkie 40 (361x277)

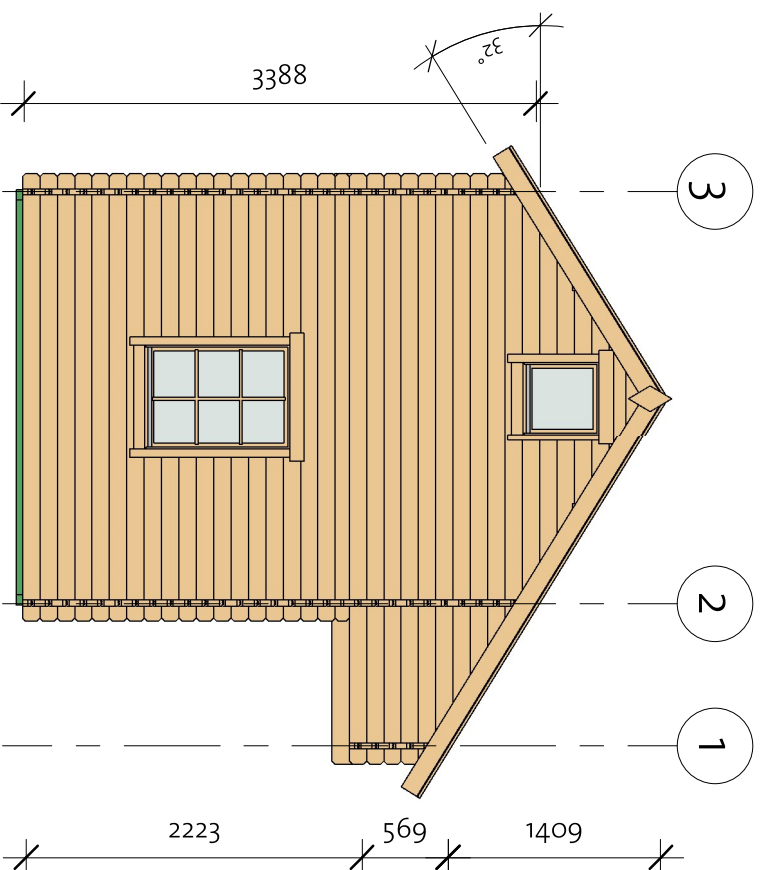
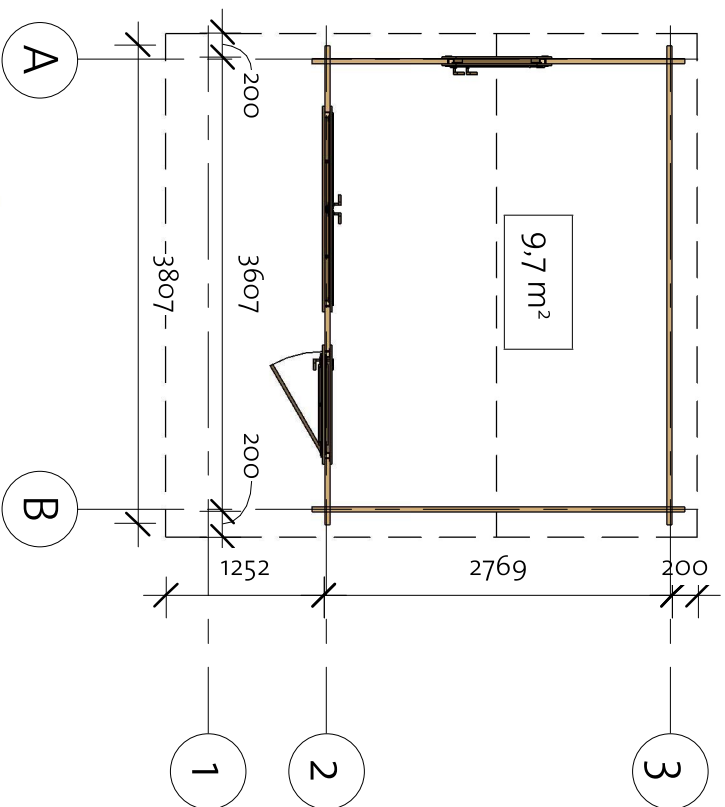

g2102081_210608

Blueberry Bunkie 40 (361x277)

Foundation

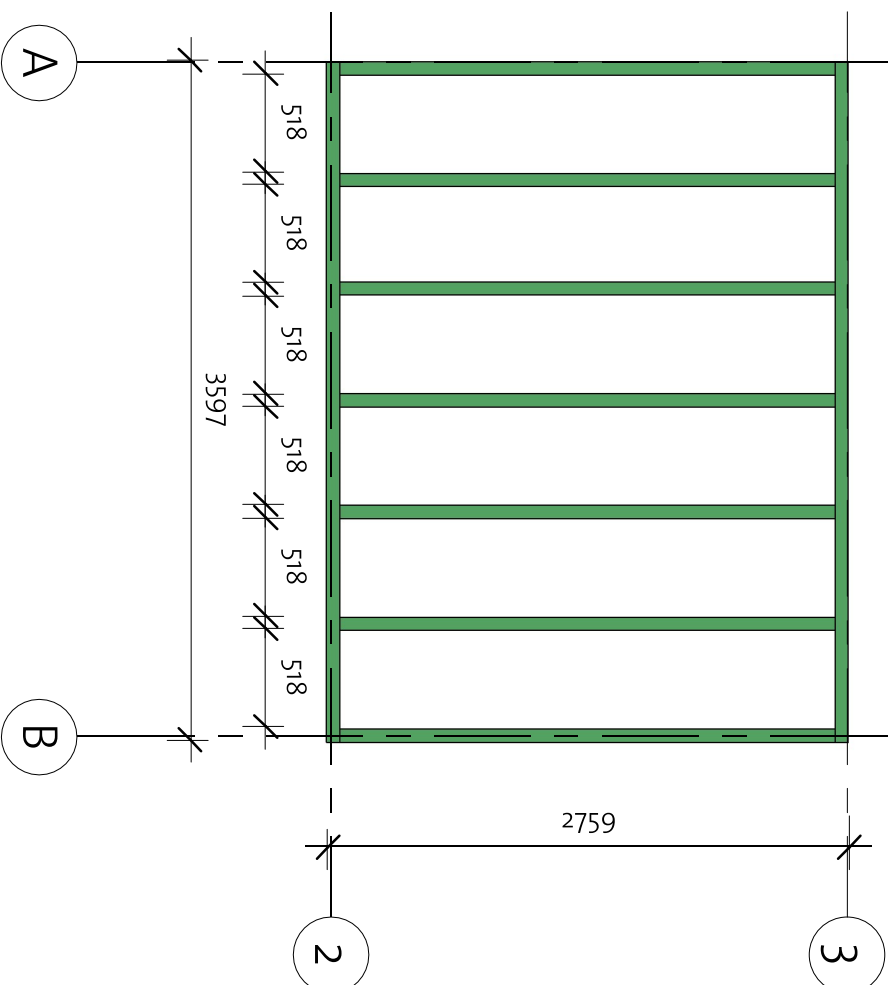

Impregnated foundation beams				
Mark	Type	Profile	Count	Length

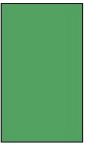
IFB1	IFB 70x40		2	3597
IFB2	IFB 70x40		7	2619



Blueberry Bunkie 40 (361x277)

Floor Plan

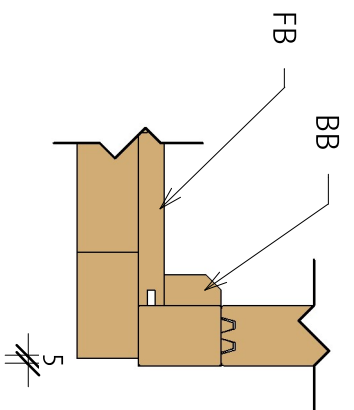
1 Baseboard

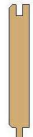

Floor Schedule

Mark	Type	Profile	Count	Length
FB	FB 17x114		58	3521
BB	BB 20x40		9	3600

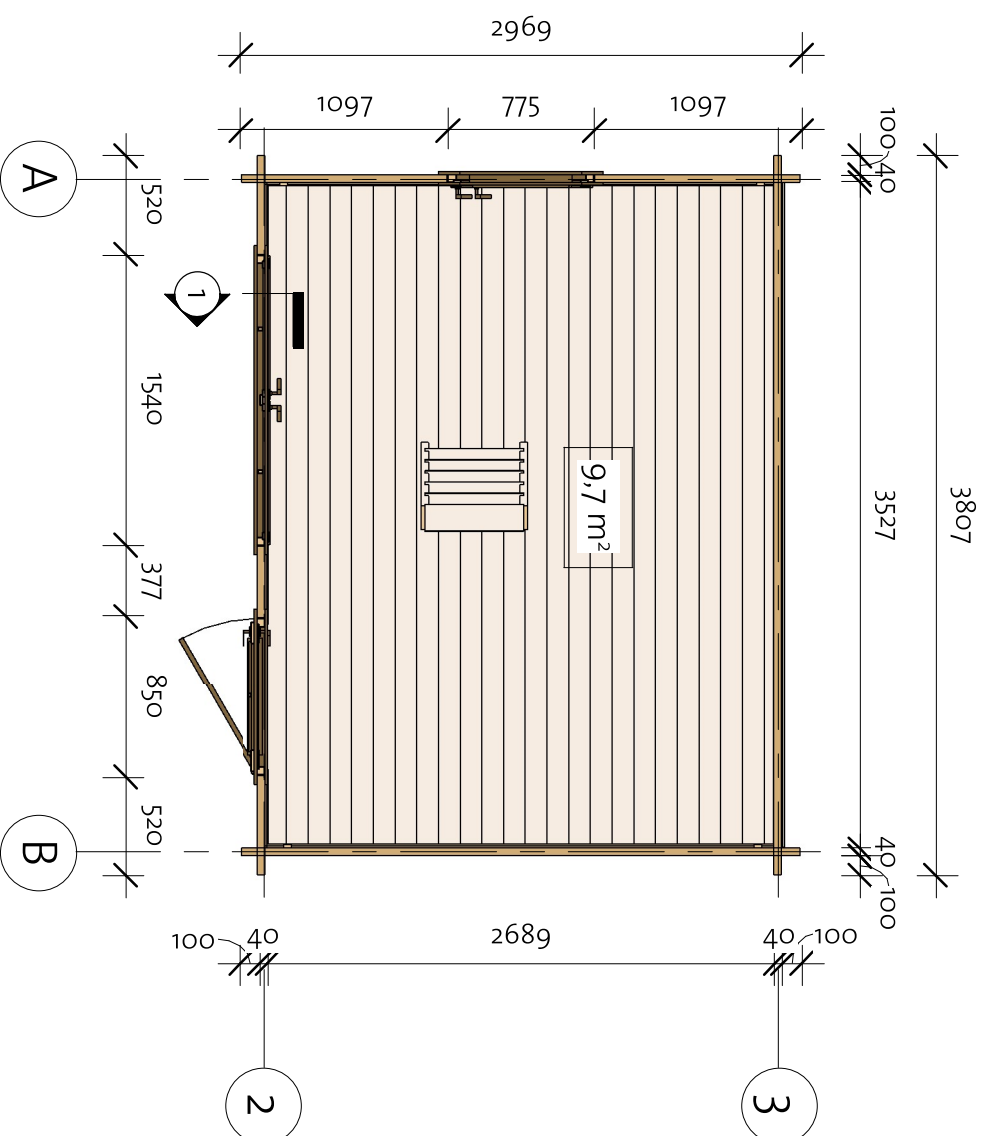

Blueberry Bunkie 40 (361x277)

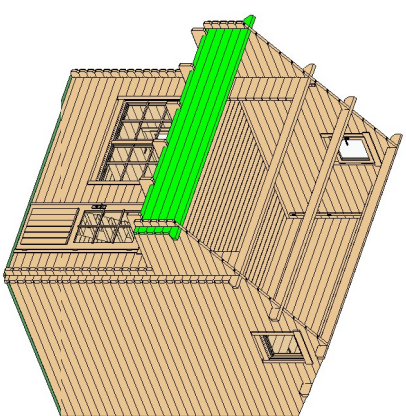

Wall 1



Wall 1			Cut
Mark	Profile	Count	Length

1BL-1	40x57	1	3807
1LG-1	40x114	4	3807
1TL-1	40x129	1	4007

Log Profile Wall 1		
Profile	Profile	Profile

40x57	
40x114	
40x129	

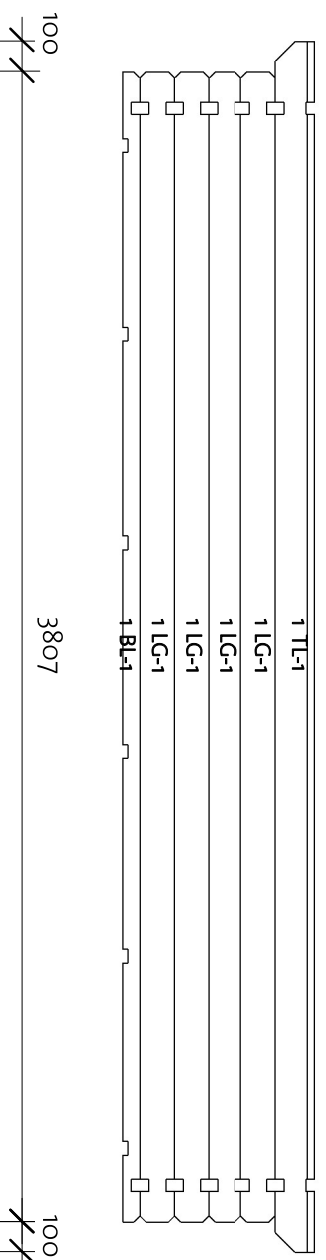

Blueberry Bunkie 40 (361x277)

Wall 2

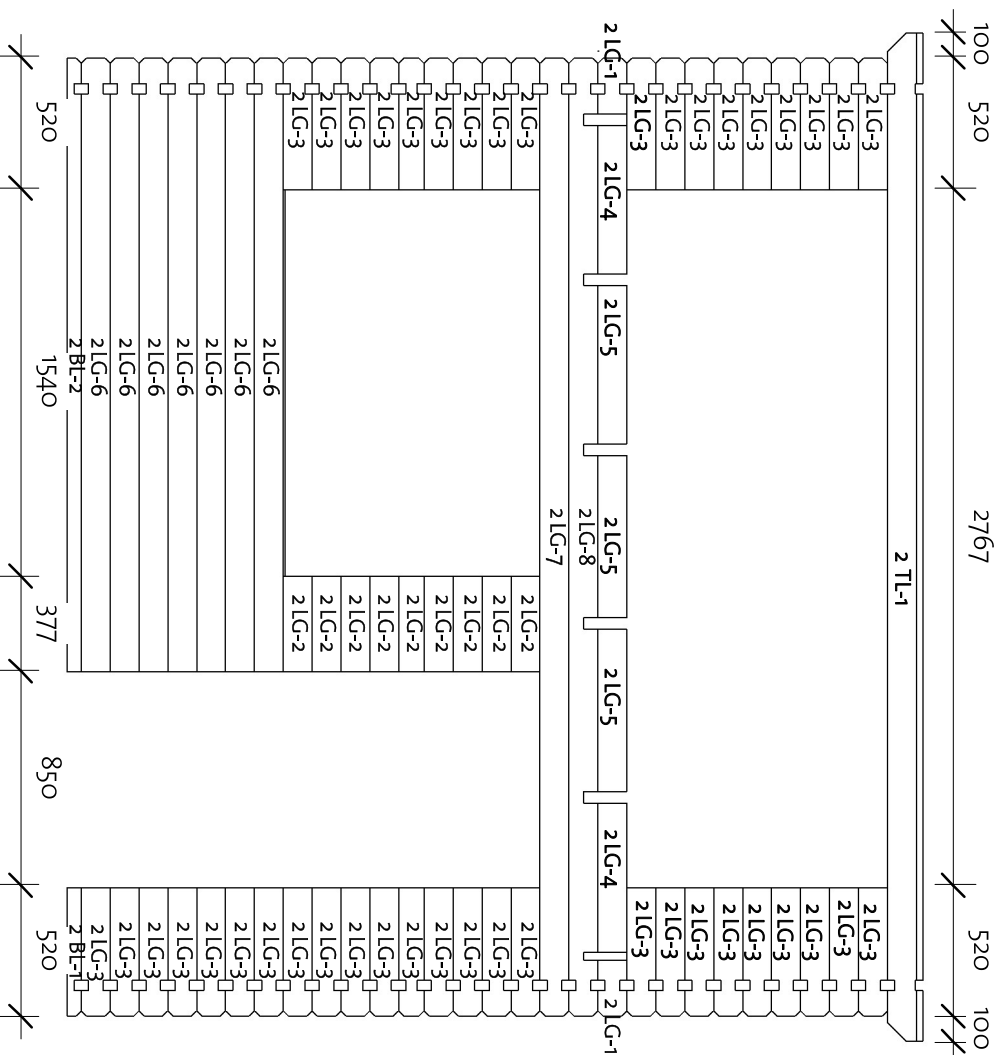
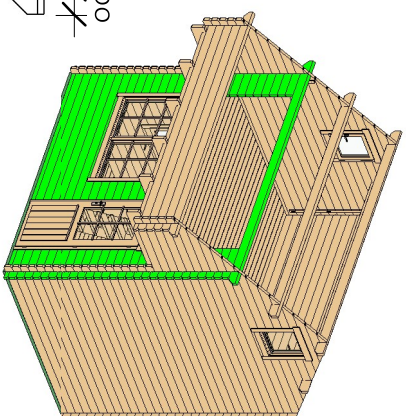

92102081_210608

Wall 2			
Mark	Profile	Count	Cut Length

2BL-1	40X57	1	520
2BL-2	40X57	1	2437
2LG-1	40X114	2	220
2LG-2	40X114	9	377
2LG-3	40X114	43	520
2LG-4	40X114	2	589
2LG-5	40X114	3	640
2LG-6	40X114	7	2437
2LG-7	40X114	1	3807
2LG-8	40X114	1	3807
2TL-1	40X139	1	4007

Log Profile Wall 2	
Profile	Profile

Log Profile Wall 2	
Profile	Profile

40X57	
40X139	

40X114	
40X114	

Blueberry Bunkie 40 (361x277)

Wall 3

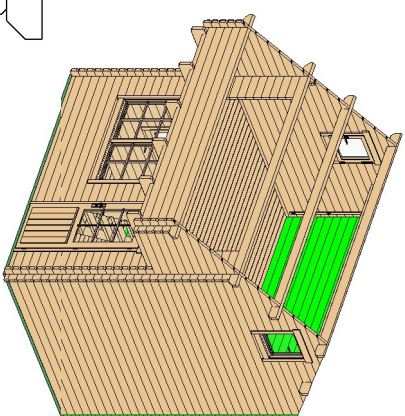

Wall 3			Cut
Mark	Profile	Count	Length

3BL-1	40x57	1	3807
3LG-1	40x114	26	3807
3LG-2	40x114	1	3807
3LG-3	40x114	3	640
3LG-4	40x114	2	220
3LG-5	40x114	2	589
3TL-1	40x139	1	4007

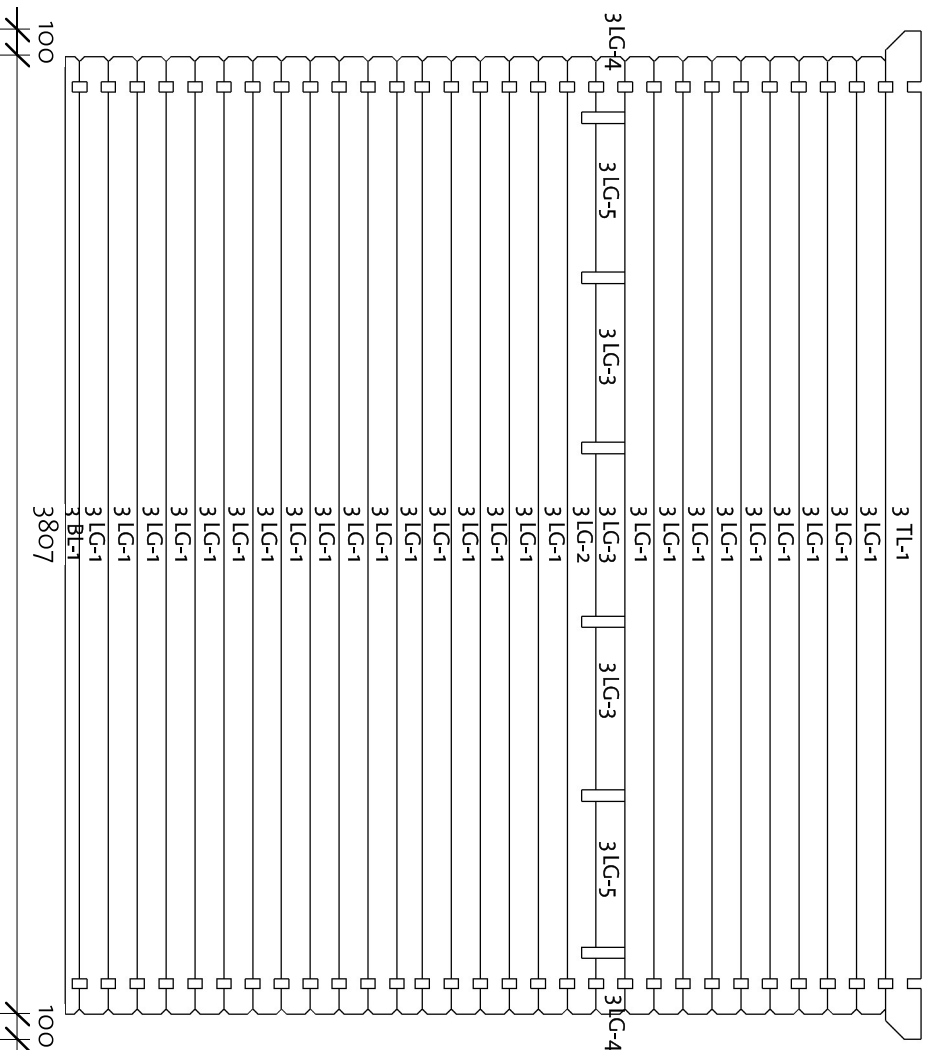

Log Profile Wall 3	
Profile	Profile

40x57	
40x114	
40x139	

92102081_210608

Blueberry Bunkie 40 (361x277)

Wall A

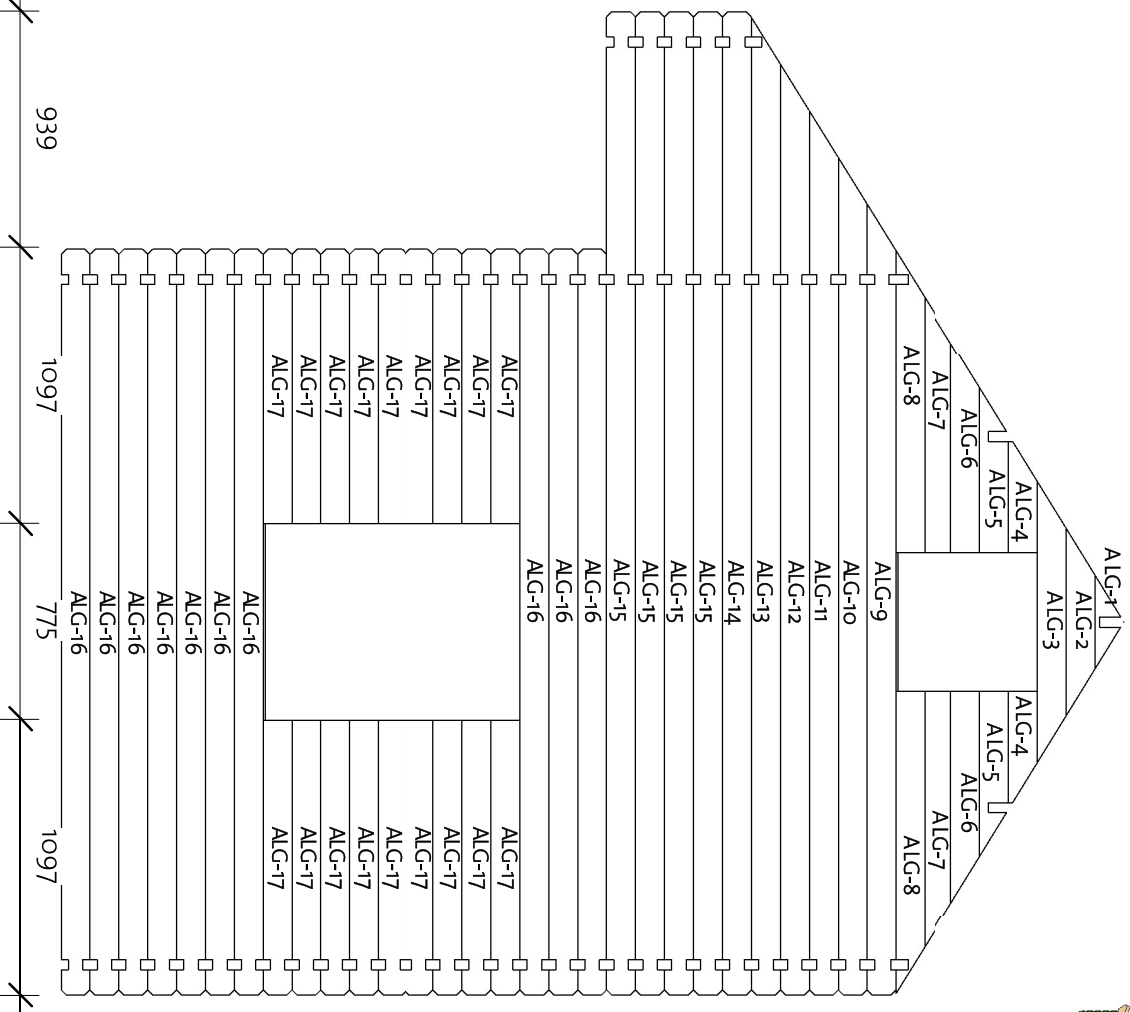
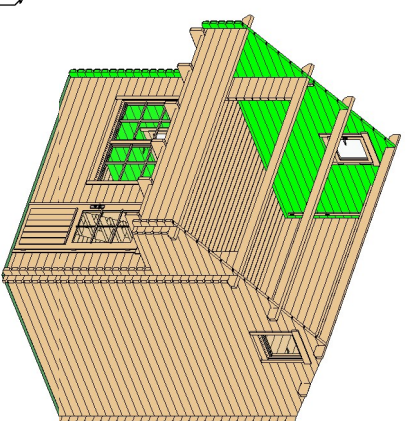

92102081_210608

Wall A			
Mark	Profile	Count	Cut Length

ALG-1 *	40x114	1	371
ALG-2 *	40x114	1	740
ALG-3 *	40x114	1	1110
ALG-4 *	40x114	2	439
ALG-5 *	40x114	2	652
ALG-6 *	40x114	2	836
ALG-7 *	40x114	2	1021
ALG-8 *	40x114	2	1206
ALG-9 *	40x114	1	3147
ALG-10 *	40x114	1	3332
ALG-11 *	40x114	1	3516
ALG-12 *	40x114	1	3701
ALG-13 *	40x114	1	3886
ALG-14 *	40x114	1	3908
ALG-15	40x114	4	3908
ALG-16	40x114	10	2969
ALG-17	40x114	18	1097

* Gable - delivered premounted

Log Profile Wall A	
Profile	Profile

40x114	
--------	---

Blueberry Bunkie 40 (361x277)

Wall B

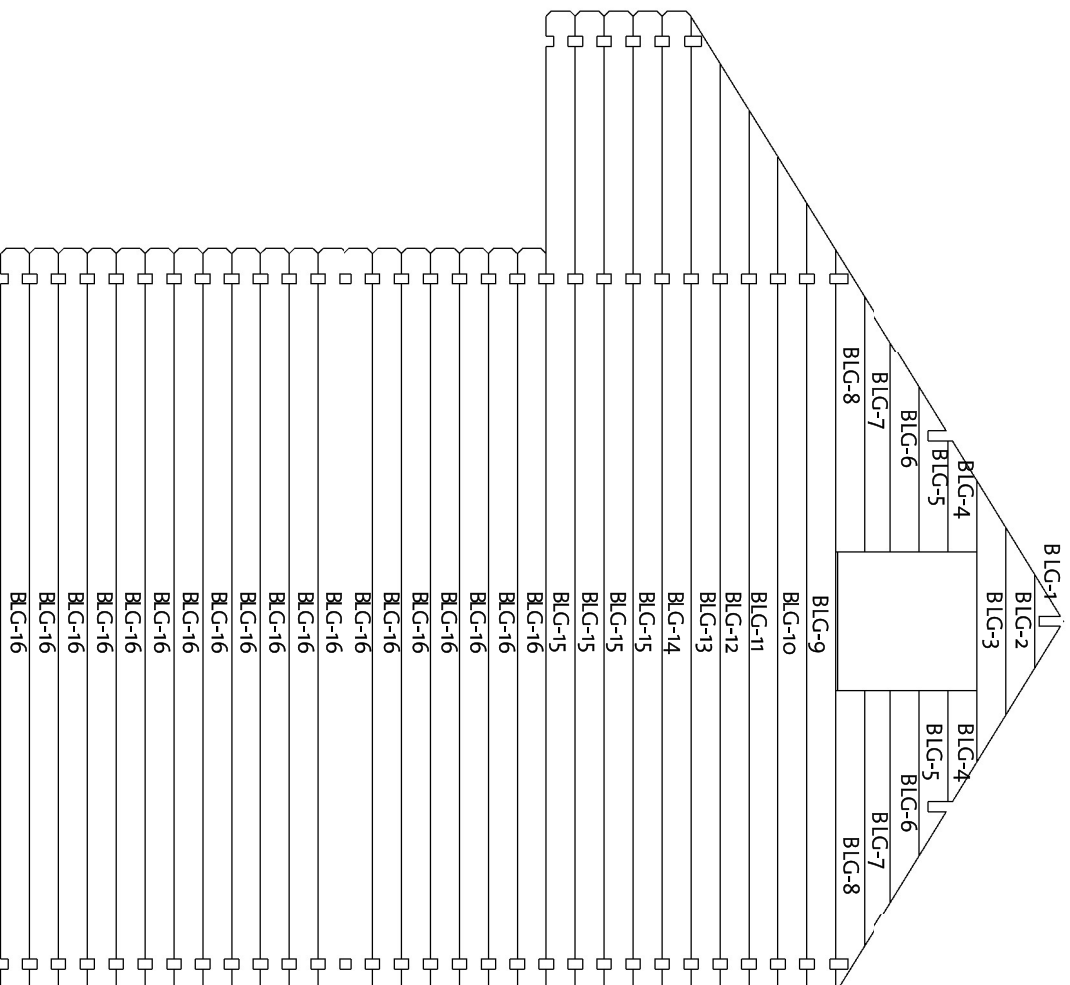
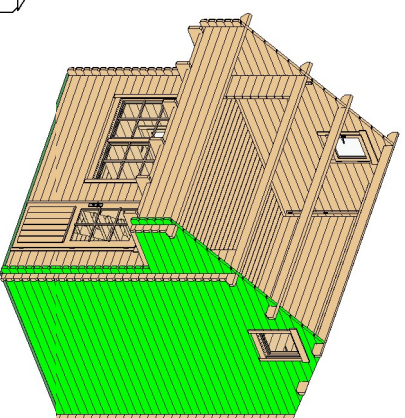

Wall B			
Mark	Profile	Count	Cut Length

BLG-1 *	40X114	1	371
BLG-2 *	40X114	1	740
BLG-3 *	40X114	1	1110
BLG-4 *	40X114	2	439
BLG-5 *	40X114	2	652
BLG-6 *	40X114	2	836
BLG-7 *	40X114	2	1021
BLG-8 *	40X114	2	1206
BLG-9 *	40X114	1	3147
BLG-10 *	40X114	1	3332
BLG-11 *	40X114	1	3516
BLG-12 *	40X114	1	3701
BLG-13 *	40X114	1	3886
BLG-14 *	40X114	1	3908
BLG-15	40X114	4	3908
BLG-16	40X114	19	2969

* Gable - delivered premounted

Log Profile Wall B	
Profile	Profile

40X114



Blueberry Bunkie 40 (361x277)

Second floor

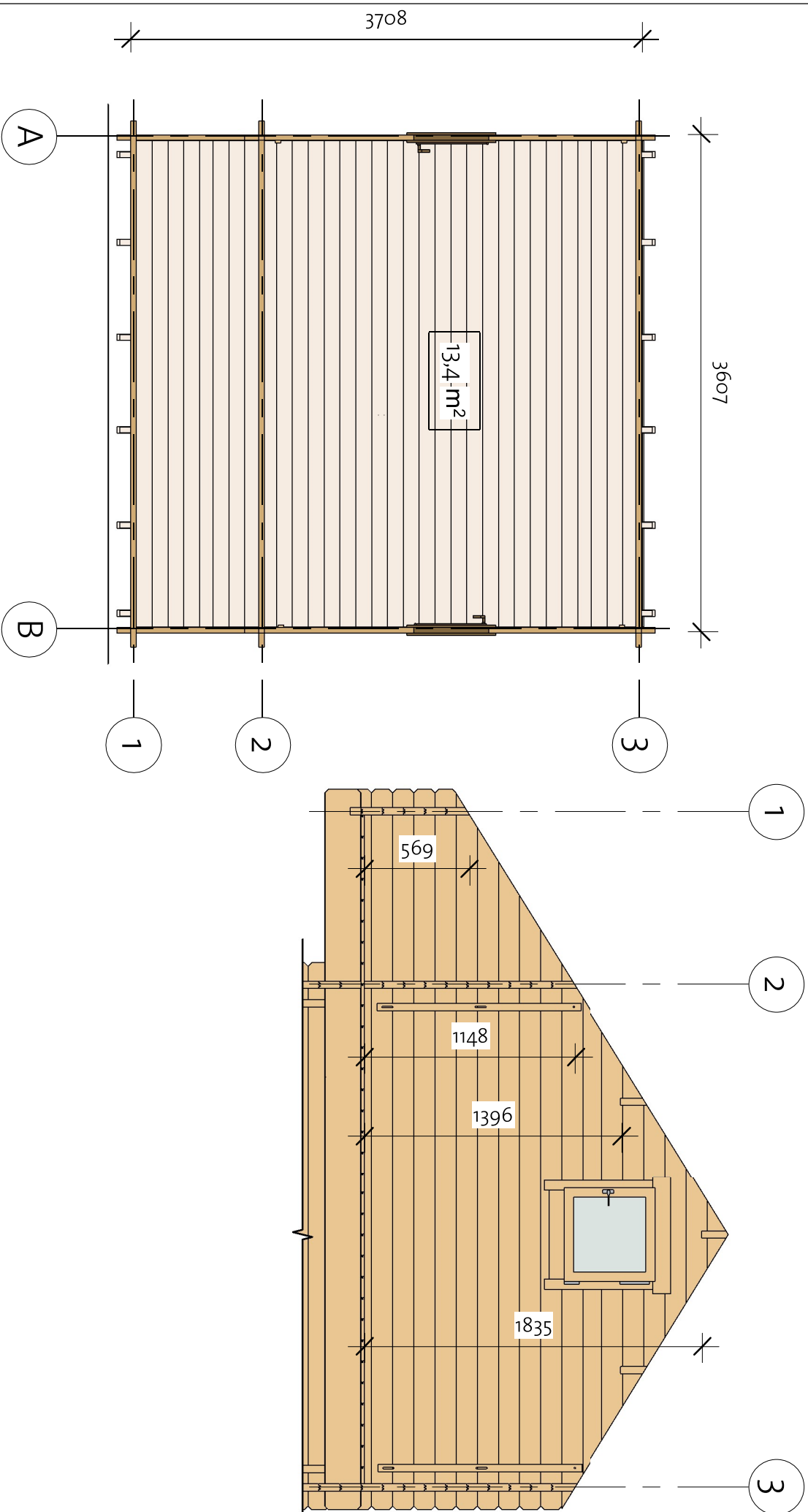

Blueberry Bunkie 40 (361x277)

Stairs

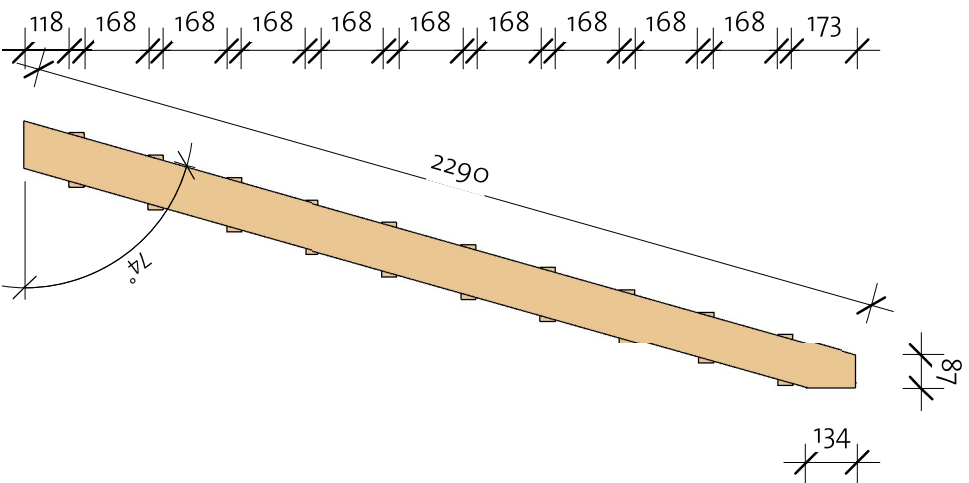
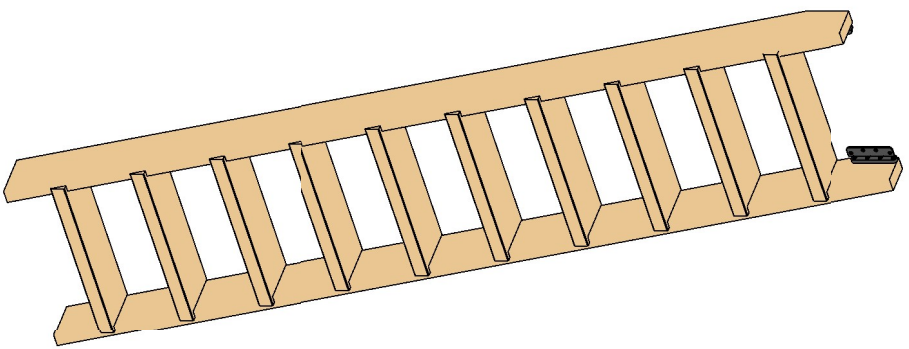

Stairs				
Mark	Profile	Profile	Count	Cut Length

ST1L	Stair	40X120	1	2313
ST1R	Stair	40X120	1	2313
ST2	Stair	143X40	10	520

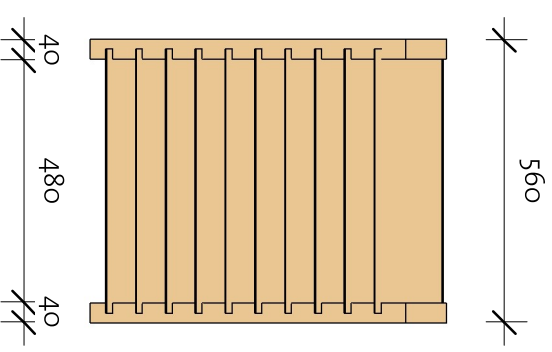

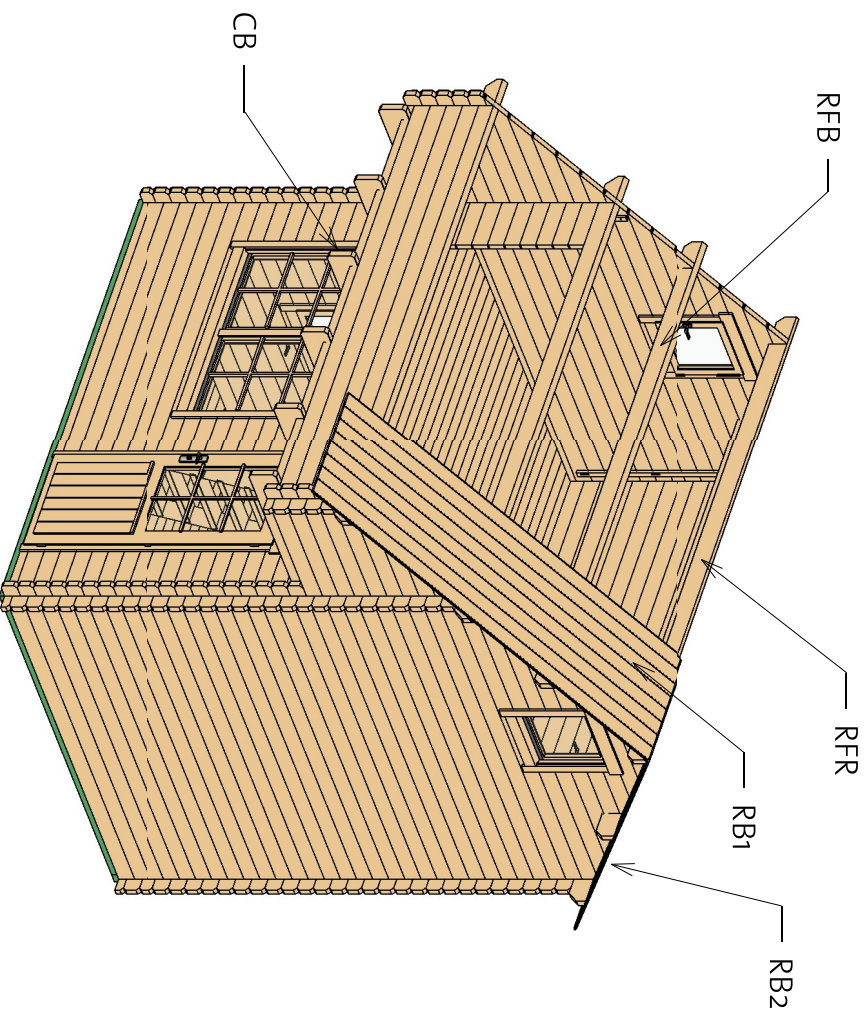

Blueberry Bunkie 40 (361x277)

Roof 1



Roof			
Mark	Type	Profile	Count Length

RB1	17x114		36	3050
RB2	17x114		36	1899
RFB	Beam 40x143		2	4007
RFR	Ridge 40x143		1	4007

Ceiling Beams			
Mark	Type	Profile	Count Length

CB	Ceiling beam 45x195		6	3908
----	---------------------------	---	---	------

Blueberry Bunkie 40 (361x277)

Roof 2

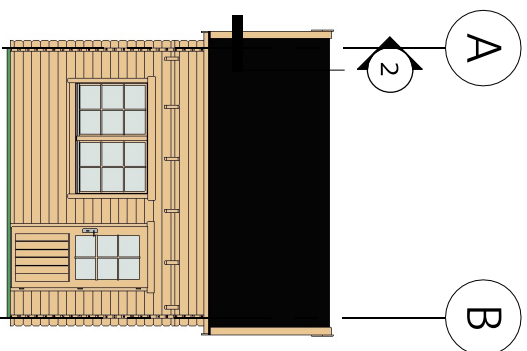

2 Roof Reinforcement

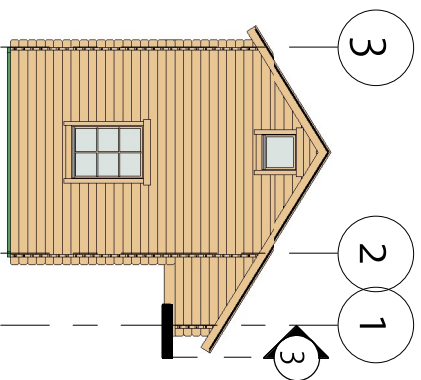
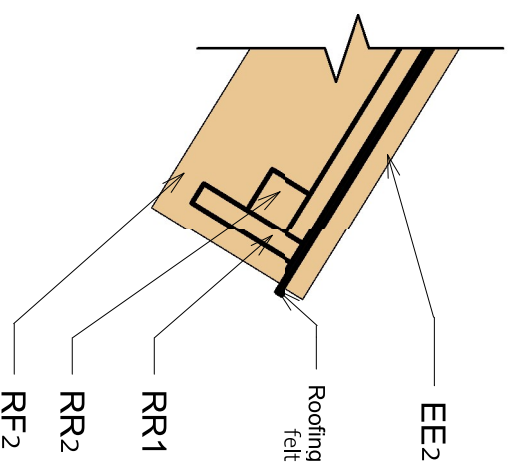

3 Fascia

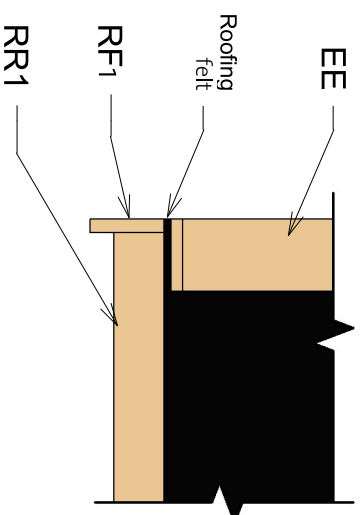

Fascia Schedule				
Mark	Type	Profile	Count	Length

EE1	Eave Edging 18x95		2	3098
EE2	Eave Edging 18x95		2	1947
RF1	Roof Fascia 18x120		2	3098
RF2	Roof Fascia 18x120		2	1947
RR1	Roof reinforcement 18x95		2	4007
RR2	Roof reinforcement 38x38		2	4007

Blueberry Bunkie 40 (361x277)

Extras

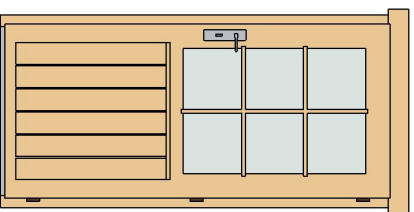

Door Schedule

Model	Type	Width	Height	Count
CD9R	Classic door 9 right	840	1835	1
DCB6	Door Crossbar 6	--	--	1

Type	Count
------	-------

Windboard 18x40x1200	4
Windboard 18x40x2200	4

Type	Count
------	-------

Romb	2
------	---

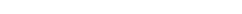
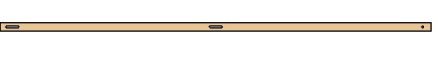

Fasteners/Extras

Name	Type	Count
Hitblock	300-400 mm	
Bolts	M8 x 70	20
Screws	5,0 x 70	65
Screws	6,0 x 140	65
Nails	1,4 x 40	70
Screws	4,0 x 40	90
Screws	4,0 x 50	700

Window Schedule

Mark	Type	Width	Height	Count
CDW1	Classic double window 1	1530	990	1
CW1R	Classic window 1 right	765	990	1
CW12R	Classic window 12, full glass right	540	540	2
WCB6	Windows Crossbar 6	--	--	3

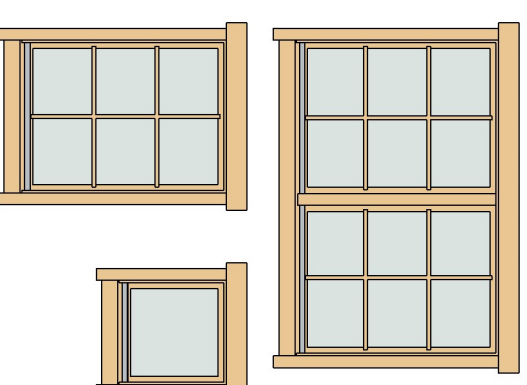

Blueberry Bunkie 40 (361x277)

List of all items 1







Impregnated foundation beams				
Mark	Type	Profile	Count	Length

IFB1	IFB 70x40		2	3597
IFB2	IFB 70x40		7	2619

Floor Schedule				
Mark	Type	Profile	Count	Length

FB	FB 17x114		58	3521
----	-----------	---	----	------

Fascia Schedule				
Mark	Type	Profile	Count	Length

EE1	Eave Edging 18x95		2	3098
EE2	Eave Edging 18x95		2	1947
RF1	Roof Fascia 18x120		2	3098
RF2	Roof Fascia 18x120		2	1947
RR1	Roof reinforcement 18x95		2	4007
RR2	Roof reinforcement 38x38		2	4007

BB	BB 20x40		9	3600
----	-------------	---	---	------

Roof				
Mark	Type	Profile	Count	Length

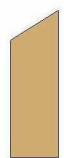
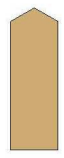
RB1	17x114		36	3050
RB2	17x114		36	1899
RFB	Beam 40x143		2	4007
RFR	Ridge 40x143		1	4007

Ceiling Beams				
Mark	Type	Profile	Count	Length

CB	Ceiling beam 45x195		6	3908
----	------------------------	---	---	------

Blueberry Bunkie 40 (361x277)

List of all items 2

Wall A			
Mark	Profile	Count	Cut Length



ALG-1*	40X114	1	371
ALG-2*	40X114	1	740
ALG-3*	40X114	1	1110
ALG-4*	40X114	2	439
ALG-5*	40X114	2	652
ALG-6*	40X114	2	836
ALG-7*	40X114	2	1021
ALG-8*	40X114	2	1206
ALG-9*	40X114	1	3147
ALG-10*	40X114	1	3332
ALG-11*	40X114	1	3516
ALG-12*	40X114	1	3701
ALG-13*	40X114	1	3886
ALG-14*	40X114	1	3908
ALG-15	40X114	4	3908
ALG-16	40X114	10	2969
ALG-17	40X114	18	1097

* Gable - delivered premounted

Wall B			
Mark	Profile	Count	Cut Length

BLG-1*	40X114	1	371
BLG-2*	40X114	1	740
BLG-3*	40X114	1	1110
BLG-4*	40X114	2	439
BLG-5*	40X114	2	652
BLG-6*	40X114	2	836
BLG-7*	40X114	2	1021
BLG-8*	40X114	2	1206
BLG-9*	40X114	1	3147
BLG-10*	40X114	1	3332
BLG-11*	40X114	1	3516
BLG-12*	40X114	1	3701
BLG-13*	40X114	1	3886
BLG-14*	40X114	1	3908
BLG-15	40X114	4	3908
BLG-16	40X114	19	2969

Stairs				
Mark	Profile	Profile	Count	Cut Length

ST1L	Stair 40X120		1	2313
ST1R	Stair 40X120		1	2313
ST2	Stair 143X40		10	520

Blueberry Bunkie 40 (361x277)

List of all items 3

Wall 1			
Mark	Profile	Count	Cut Length

1BL-1	40x57	1	3807
1LG-1	40x114	4	3807
1TL-1	40x129	1	4007

Wall 3			
Mark	Profile	Count	Cut Length

3BL-1	40x57	1	3807
3LG-1	40x114	26	3807
3LG-2	40x114	1	3807
3LG-3	40x114	3	640
3LG-4	40x114	2	220
3LG-5	40x114	2	589
3TL-1	40x139	1	4007



Wall 2			
Mark	Profile	Count	Cut Length

2BL-1	40x57	1	520
2BL-2	40x57	1	2437
2LG-1	40x114	2	220
2LG-2	40x114	9	377
2LG-3	40x114	43	520
2LG-4	40x114	2	589
2LG-5	40x114	3	640
2LG-6	40x114	7	2437
2LG-7	40x114	1	3807
2LG-8	40x114	1	3807
2TL-1	40x139	1	4007

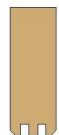
Log profiles	
Profile	Profile

40x57	
40x114	

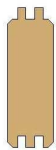
Log profiles	
Profile	Profile

40x114	
40x129	
40x139	